

OUTLINE DIMENSIONAL DRAWING

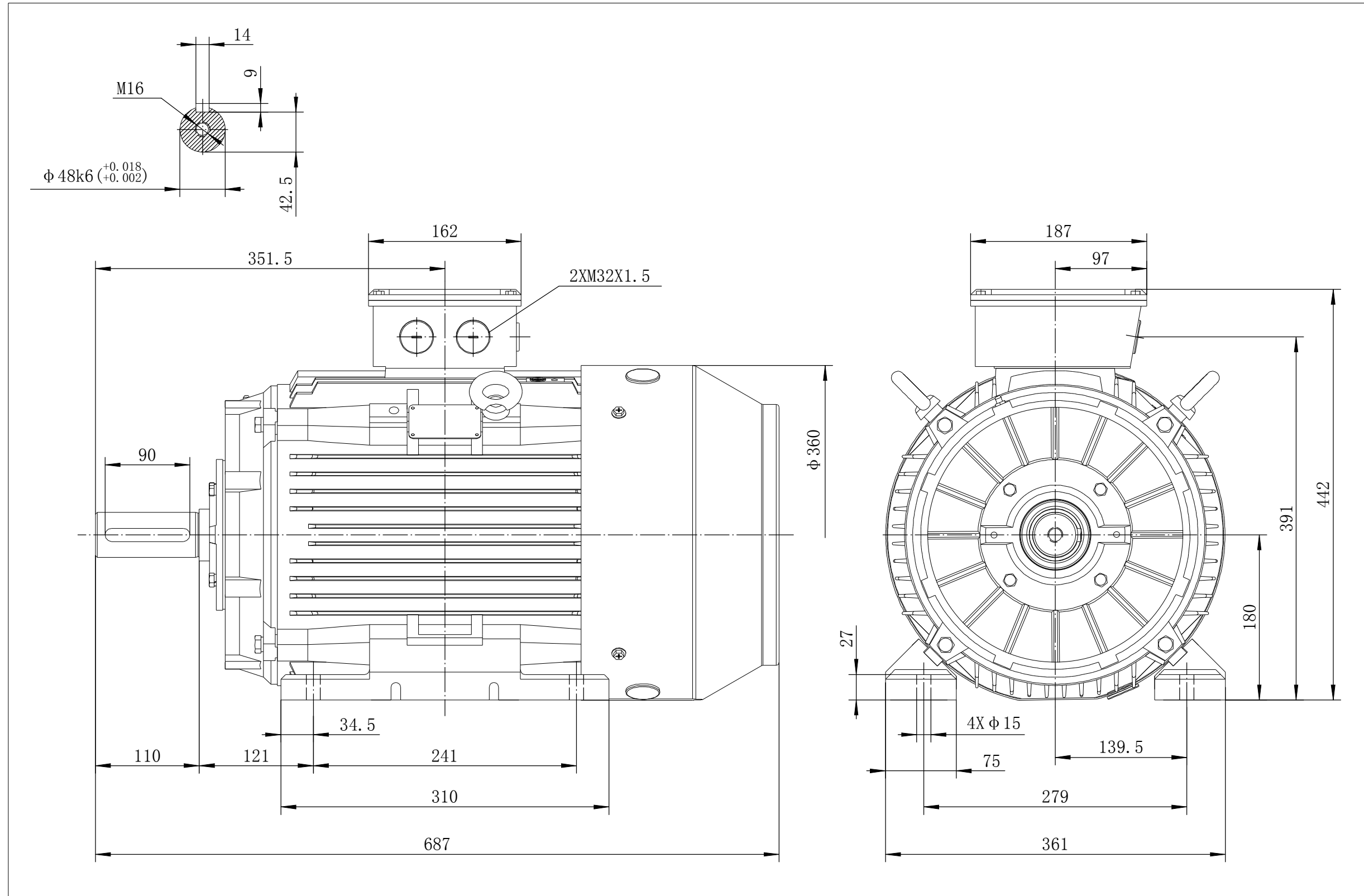

TECHTOP AUSTRALIA PTY LTD	
FRAME	TCI 180M B3
DATE	DRAWING NO.
2012/05/10	1HMY. 010. T055B